

A strong team for economical concrete paving.

Slipform Paver SP 1500 / SP 1500 L

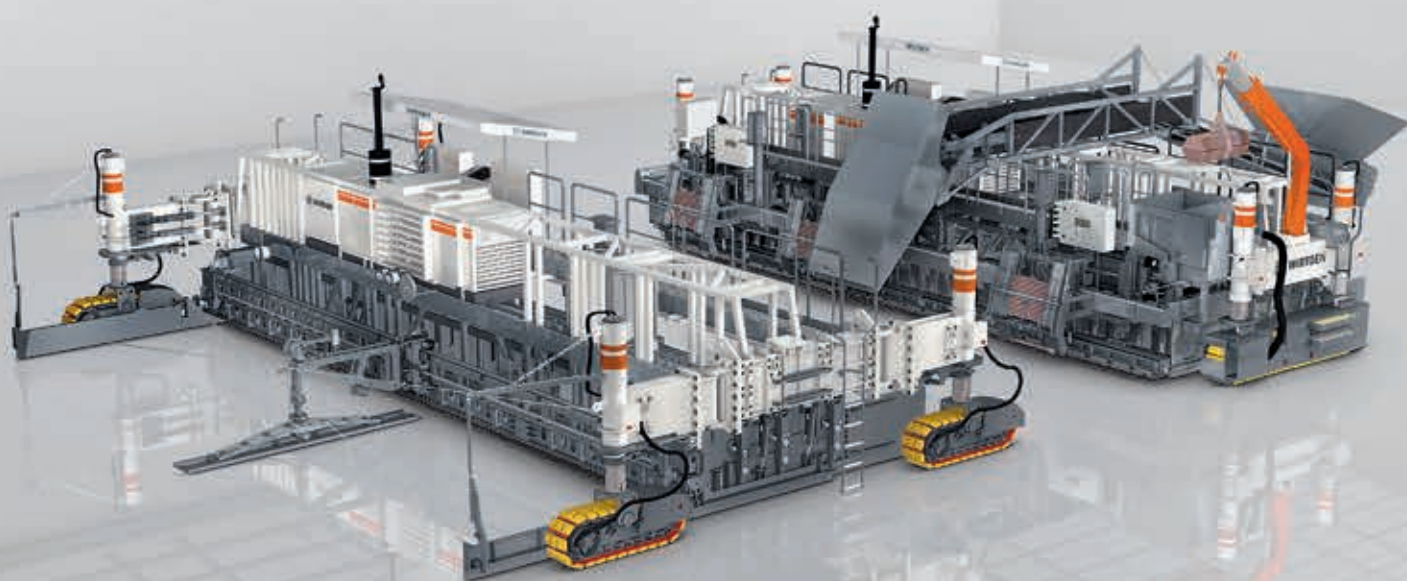

Outstanding features of the SP 1500 slipform paver

02
03

2 | BOTTOM-LAYER CONCRETE PAVER SP 1500

As bottom-layer concrete paver in dual-layer concrete paving, the SP 1500 paves the bottom concrete layer.

1 | TOP-LAYER CONCRETE PAVER SP 1500

As top-layer concrete paver in dual-layer concrete paving, the SP 1500 paves the top concrete layer "wet-in-wet".

3 | PIVOTING LEGS

Pivoting legs for full adjustment of the track units to the conditions prevailing on site.

4 | TRACK UNITS

Hydraulically driven, separately height-adjustable and steerable track units for precise driving behaviour and high-precision concrete paving.

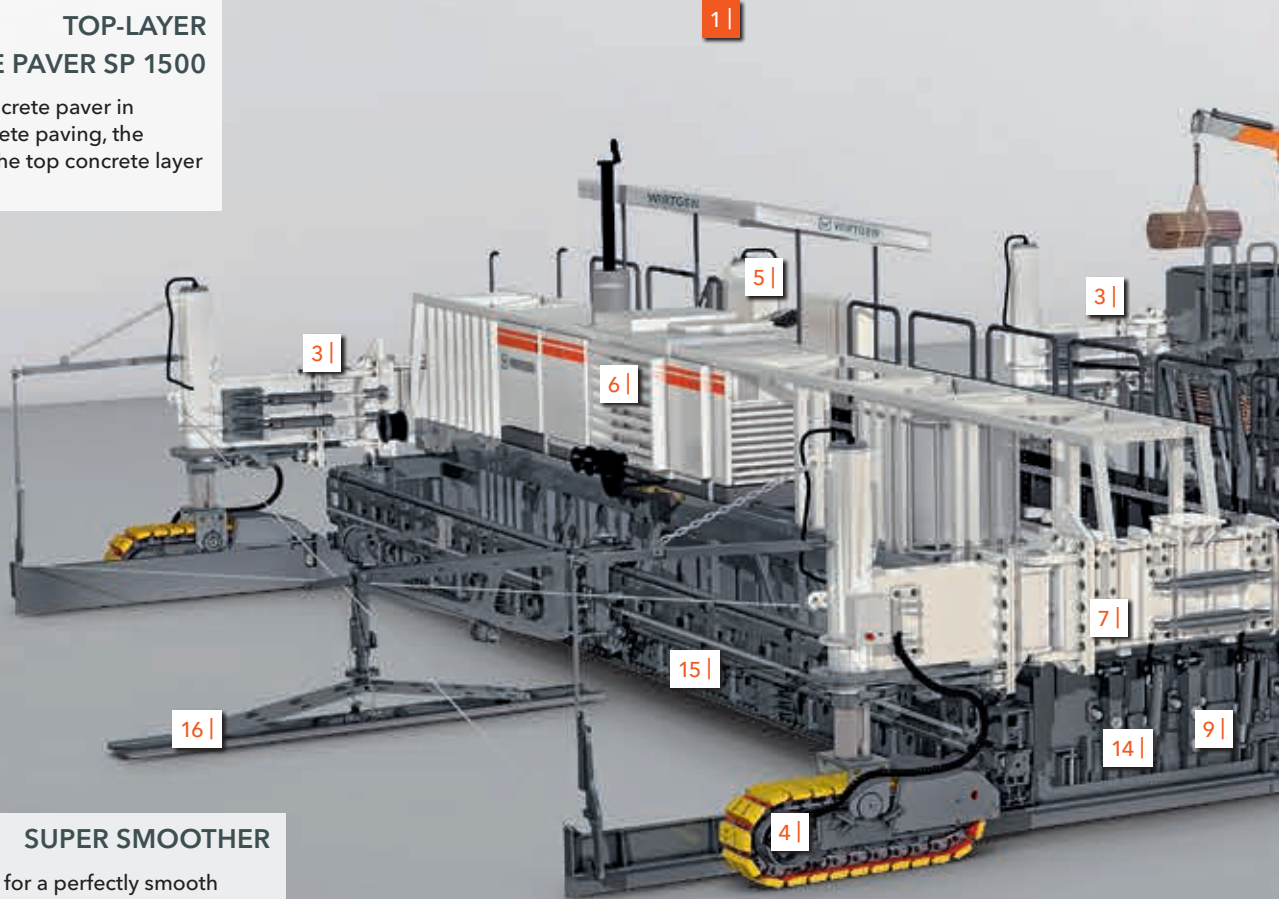

16 | SUPER SMOOTHER

Super smoother for a perfectly smooth surface finish.

15 | OSCILLATING BEAM

Eccentrically driven oscillating beam for the production of smooth concrete surfaces.

14 | SIDE TIE BAR INSERTER

Automated insertion of side tie bars when paving adjacent concrete slabs.

13 | LONGITUDINAL JOINT TIE BAR INSERTER

Automated insertion of longitudinal joint tie bars to prevent concrete slabs from drifting apart.

5 | OPERATOR'S PLATFORM

Ergonomically designed, walk-through operator's platform for non-tiring, productive working.

6 | POWER UNIT

High-powered, fuel-efficient diesel engine for concrete paving in the optimum performance and torque ranges.

7 | TELESCOPING MACHINE FRAME

Machine frame telescoping in longitudinal direction to allow full adjustment to site conditions.

8 | CONVEYING SYSTEM

Conveying system for transport of the top-layer concrete in front of the top-layer concrete paver.

9 | INSET PAVING MOULD

Inset paving mould integrated into the machine frame and mounted between the track units.

10 | CONCRETE SPREADING

Spreading plough for even distribution of the freshly delivered concrete in front of the inset paving mould.

12 | DOWEL BAR INSERTER

Automated insertion of dowel bars to maintain the surface levels of neighbouring concrete slabs.

11 | VIBRATORS

Electrically driven vibrators for reliable concrete compaction.

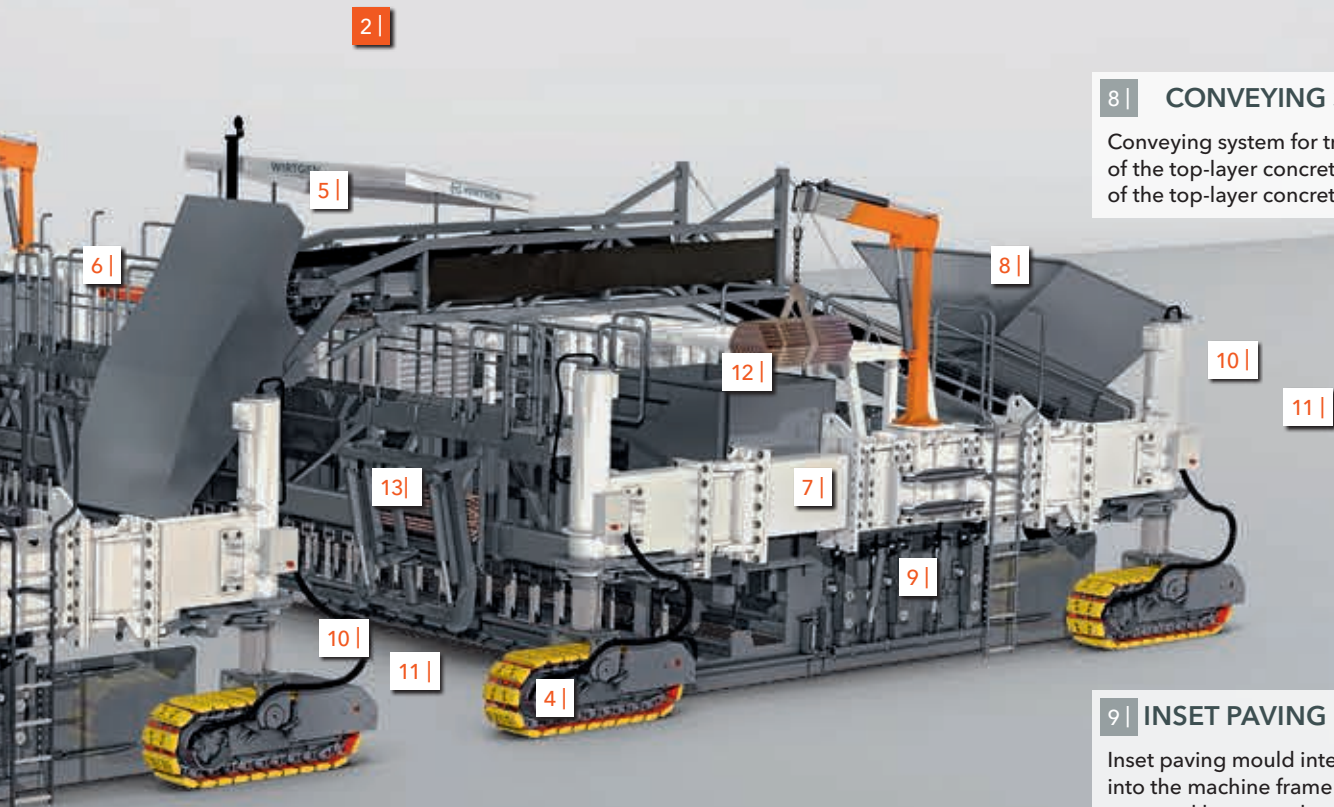

Outstanding features of the SP 1500 L slipform paver

04
05

1 | TOP-LAYER CONCRETE PAVES SP 1500 L

As top-layer concrete paver in dual-layer concrete paving, the SP 1500 L paves the top concrete layer "wet-in-wet".

2 | BOTTOM-LAYER CONCRETE PAVES SP 1500 L

As bottom-layer concrete paver in dual-layer concrete paving, the SP 1500 L paves the bottom concrete layer.

3 | TRACK UNITS

Hydraulically driven, height-adjustable track units for precise driving behaviour and high-precision concrete paving.

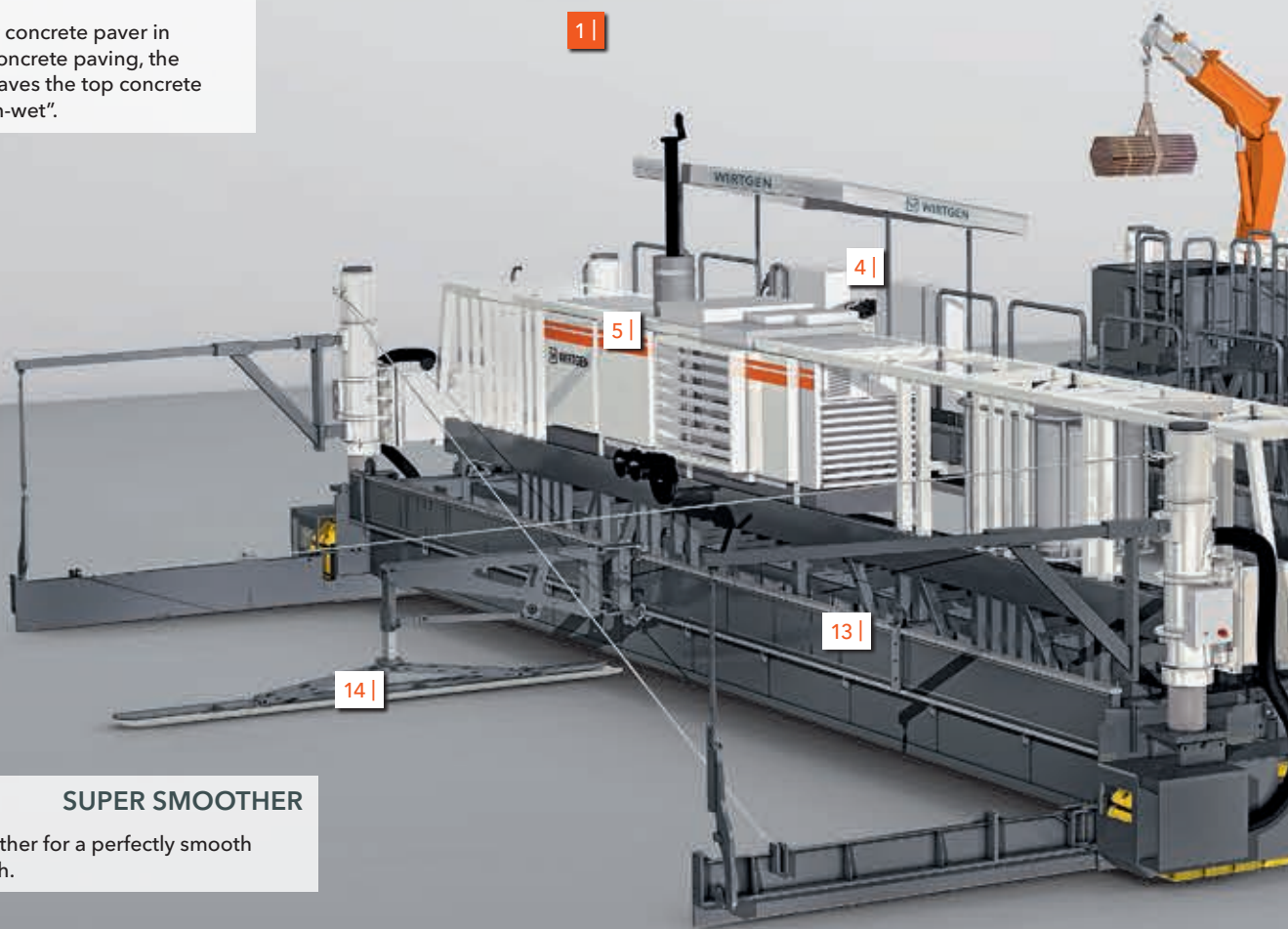

14 | SUPER SMOOTHER

Super smoother for a perfectly smooth surface finish.

13 | OSCILLATING BEAM

Eccentrically driven oscillating beam for the production of smooth concrete surfaces.

12 | LONGITUDINAL JOINT TIE BAR INSERTER

Automated insertion of longitudinal joint tie bars to prevent concrete slabs from drifting apart.

11 | SIDE TIE BAR INSERTER

Automated insertion of side tie bars when paving adjacent concrete slabs.

4 | OPERATOR'S PLATFORM

Ergonomically designed, walk-through operator's platform for non-tiring, productive working.

5 | POWER UNIT

High-powered, fuel-efficient diesel engine for concrete paving in the optimum performance and torque ranges.

6 | CONVEYING SYSTEM

Conveying system for transport of the top-layer concrete in front of the top-layer concrete paver.

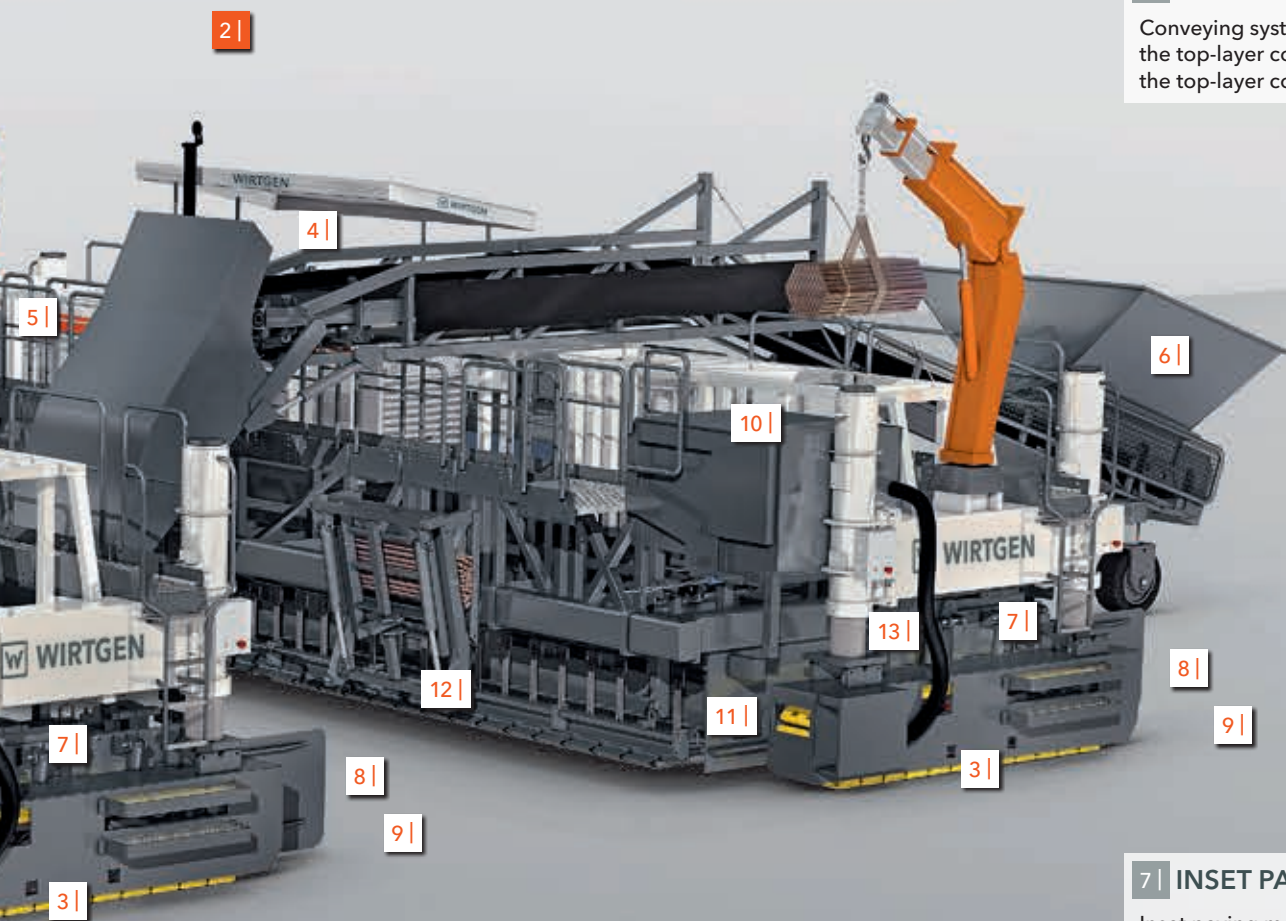

7 | INSET PAVING MOULD

Inset paving mould integrated into the machine frame and mounted between the track units.

8 | CONCRETE SPREADING

Spreading plough for even distribution of the freshly delivered concrete in front of the inset paving mould.

10 | DOWEL BAR INSERTER

Automated insertion of dowel bars to maintain the surface levels of neighbouring concrete slabs.

9 | VIBRATORS

Electrically driven vibrators for reliable concrete compaction.



ROAD TRANSPORT IS INCREASING CONTINUOUSLY. TECHNOLOGICAL DEVELOPMENT IS FORGING AHEAD AT AN EVER FASTER PACE. OFFERING YOU MORE OPPORTUNITIES - ALSO IN CONCRETE ROAD CONSTRUCTION. WE ARE A KEY PLAYER IN DRIVING THIS DEVELOPMENT WITH PIONEERING TECHNOLOGIES. WITH THE SP 1500 L AND SP 1500 SLIPFORM PAVER. A MOBILE ROAD CONSTRUCTION PLANT. EXPERTISE IN HIGHLY AUTOMATED CONCRETE PAVING. FOR DURABLE ROADS OF EXCELLENT DIMENSIONAL STABILITY. THE SP 1500 L AND SP 1500 - PREDESTINED FOR TOP PERFORMANCE.



Fully focused

on top performance.



1 |

Intelligence in concrete paving: this paving train is a high-speed train

HIGH-QUALITY DUAL-LAYER CONCRETE PAVEMENTS

WIRTGEN uses an efficient, tried-and-tested process for the production of dual-layer concrete pavements: the paving train consists of three separate units comprising the bottom-layer paver, top-layer paver and TCM texture curing machine. In the paving process, the SP 1500/SP 1500 L slipform paver can be used as bottom-layer paver or top-layer paver in accordance with customer specifications.

The intelligent concrete paving process and resulting high daily performance rates, ease of transport and a variety of adjustment options enable the paving train to produce high-quality dual-layer concrete pavements at widths of up to 15.25 m economically and in record time.

The SP 1500 L is equipped with two track units, whilst the SP 1500 features four track units for increased flexibility. Separation of the two paving units ensures ease of transport and requires little effort for setup and disassembly. The high degree of automation of the SP 1500/SP 1500 L additionally results in efficient performance.

Paving two layers of concrete simultaneously is an approved method for the economically efficient production of concrete pavements.



1 | Efficient: bottom-layer concrete and top-layer concrete are paved in immediate succession.

2 | The SP 1500 L and SP 1500 are used as either bottom-layer paver or top-layer paver in accordance with requirements.

Use as required: concrete paving with the SP 1500 or SP 1500 L

10
11

CHOICE OF DIFFERENT COMBINATIONS:

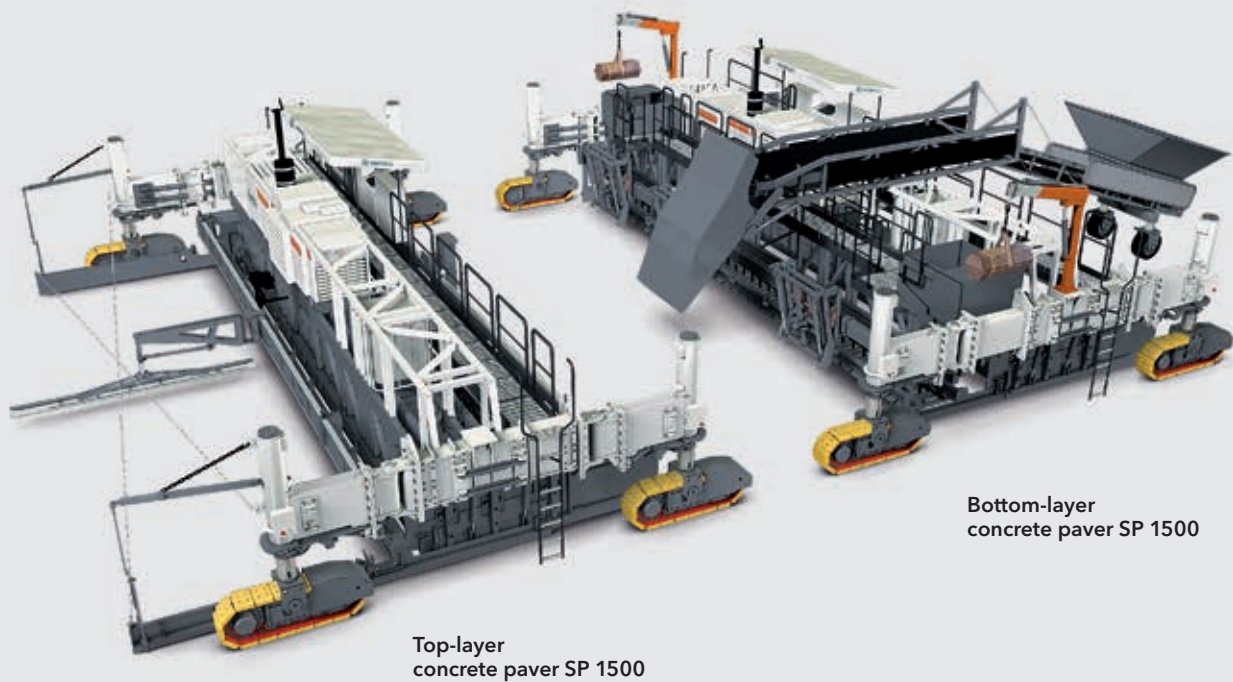

TWO OR FOUR TRACK UNITS

Depending on requirements, customers can use the SP 1500 with four or the SP 1500 L with two track units as the bottom-layer or top-layer concrete paver. The two-tracked SP 1500 L slipform paver model offers the advantages of lower machine weight and shorter transport length.

The four-tracked SP 1500, on the other hand, offers a significantly larger contact surface, thus effectively preventing the machine from sinking in on soft ground. In addition, each of the SP 1500's four track units can be adjusted, steered and pivoted about 90 degrees separately and hydraulically for improved manoeuvrability. Hydraulically adjustable pivoting legs enable track adjustment which allows the SP 1500 to be easily adapted to any fixed obstacles on the paving site.

Being equipped with four track units, the SP 1500 can easily turn on its axis which is helpful, for example, for repositioning or manoeuvring the machine.

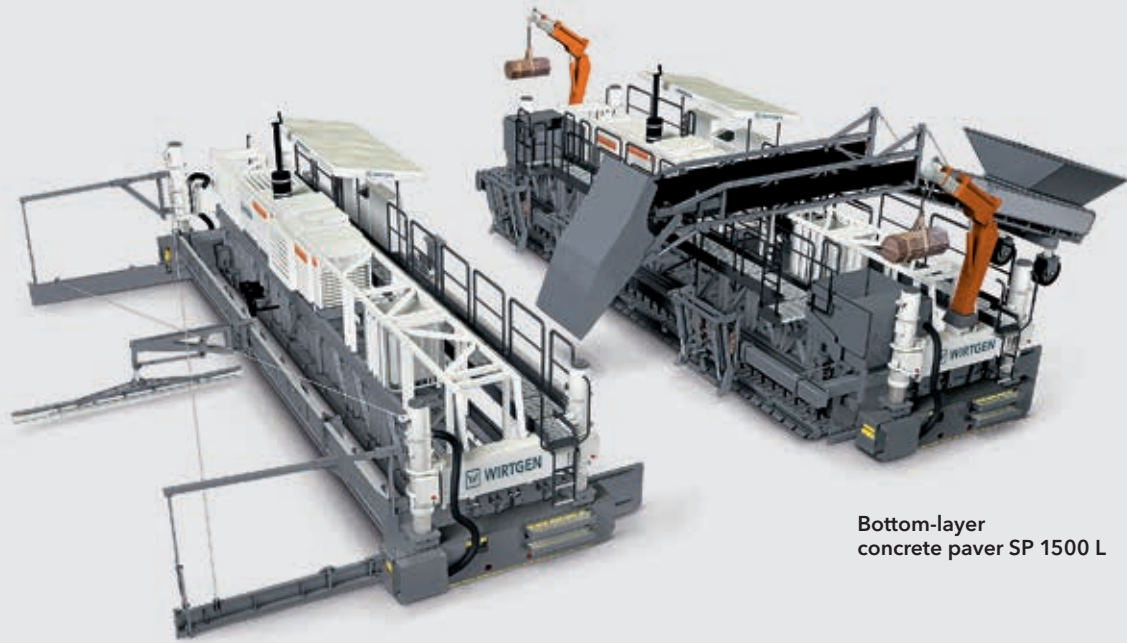

Bottom-layer
concrete paver SP 1500 L

Top-layer
concrete paver SP 1500 L

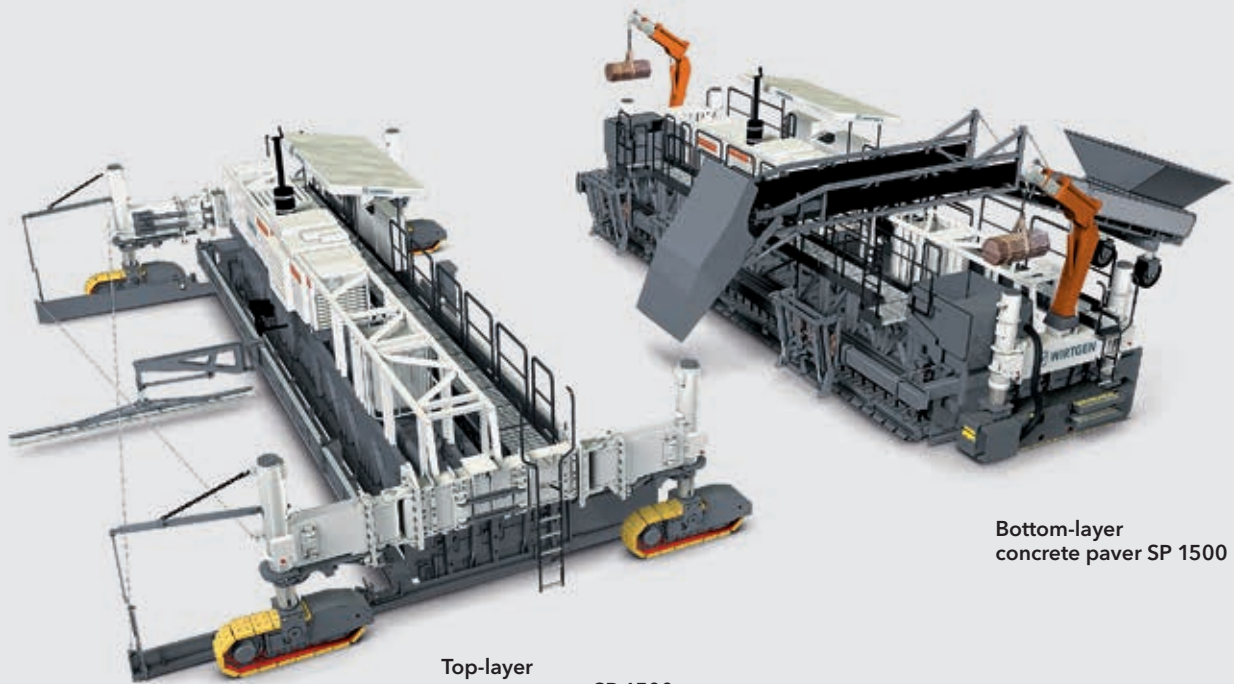

Bottom-layer
concrete paver SP 1500 L

Top-layer
concrete paver SP 1500



11

Save time and money starting with the bottom concrete layer

A RELIABLE PAVING METHOD FOR SUPERIOR RESULTS

Deposit the concrete for the bottom layer in front of the SP 1500/SP 1500 L, and the machine will take care of the rest virtually automatically: a truck dumps the concrete in front of the bottom-layer paver, which spreads it evenly across the entire width using a spreading plough.

A heavy-duty mould paves the concrete in the correct vertical and horizontal position while the paver keeps moving forward. Electrically

driven vibrators then compact the concrete using high-frequency vibration while dowel bars and tie bars are inserted into the bottom concrete layer with pinpoint accuracy. A cost-efficient, homogeneous layer is thus produced which is an ideal base for the top-layer concrete.

Two or four track units provide excellent stability and good traction regardless of ground conditions. Positioning the track units close to the concrete slab results in lower costs when producing the hydraulically bound base layer.

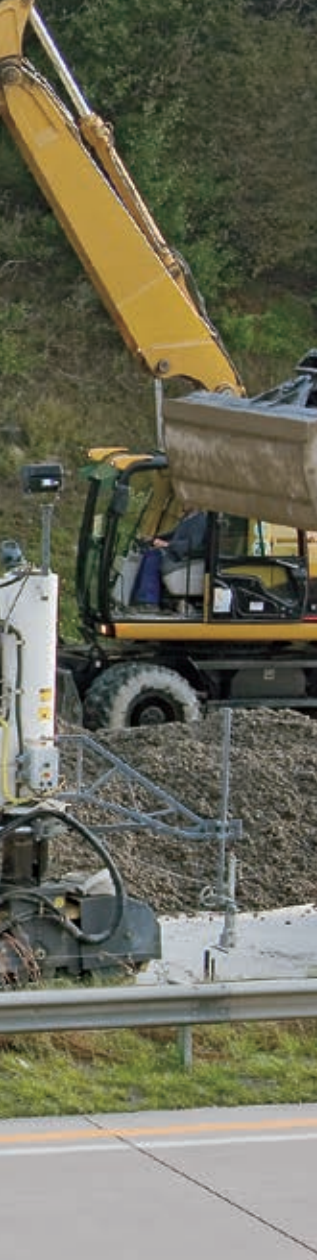

1 | Economical paving of inexpensive bottom-layer concrete at working widths ranging from 5.0 m to 15.25 m.

2 | Sensor for level and steering control; the track unit travels close to the concrete slab.

3 | The spreading plough distributes the previously deposited concrete for the bottom layer across the entire width.

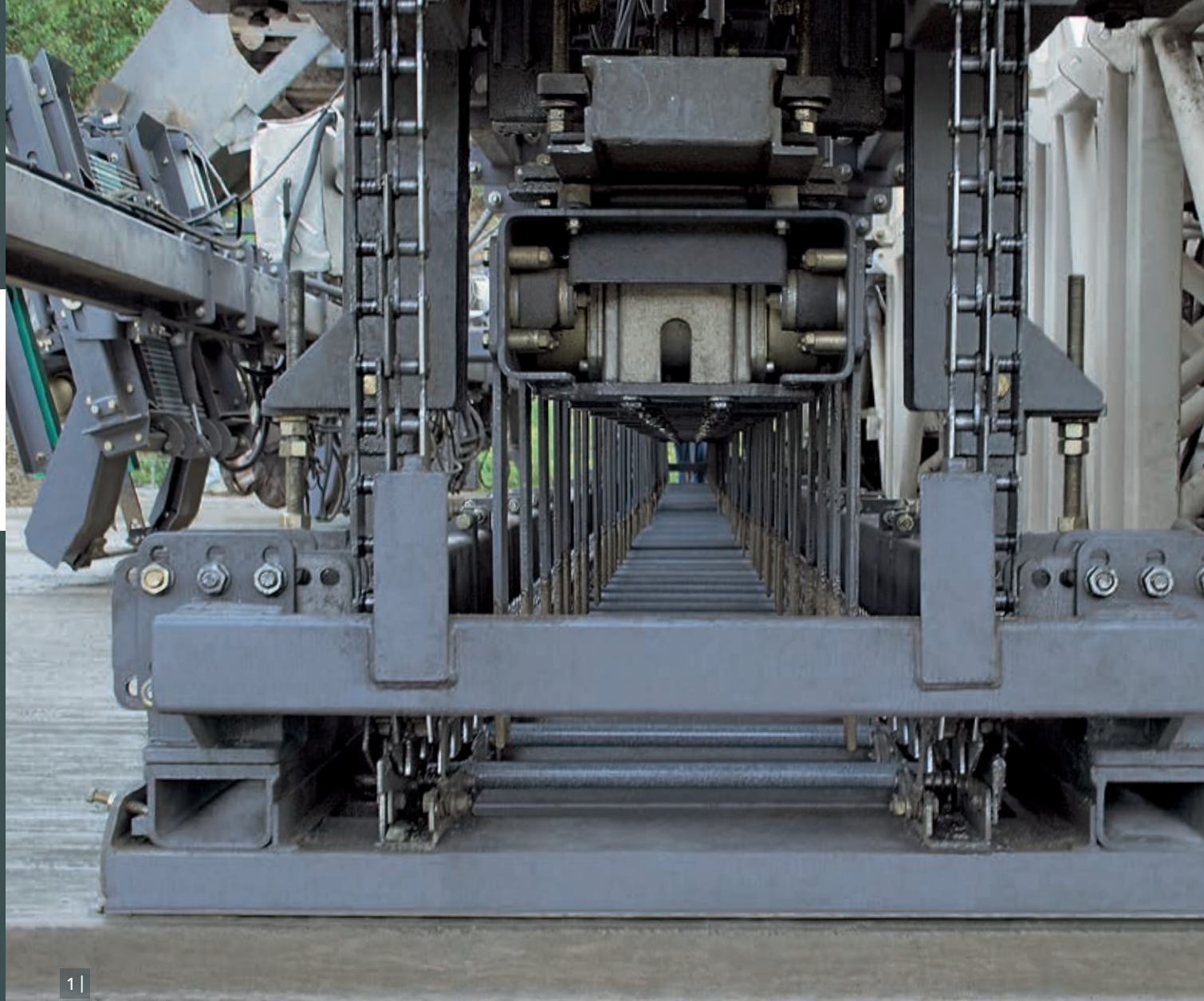

11

No need to interrupt production: automated insertion of dowel bars

TOTAL AUTOMATION HELPS YOU EXPLOIT ALL COST-CUTTING POTENTIAL

The SP 1500/SP 1500 L has yet another trump card to offer: automated insertion of dowel bars and tie bars into the concrete layer. The dowel bars are inserted parallel, the tie bars perpendicular to the concrete slab by means of vibration. Highlight of the process: the dowel bar inserter mounted on the machine can move in the direction of paving, meaning that it remains above the paving site without interrupting machine travel until the dowel bars have been accurately inserted into the concrete. Dowel bars and tie bars are inserted

in a fully automated process. Labour requirements for dowel bar distribution are therefore reduced to process monitoring.

Dowel bar and tie bar lengths and intervals can be adapted in accordance with project requirements.



1 | The dowel bar inserter remains above the paving site as the machine travels.

2 | Automated insertion of the tie bars.

3-4 | The tie bars are inserted into the bottom-layer concrete with pinpoint precision.

5 | The top-layer concrete is conveyed over and across the bottom-layer paver.



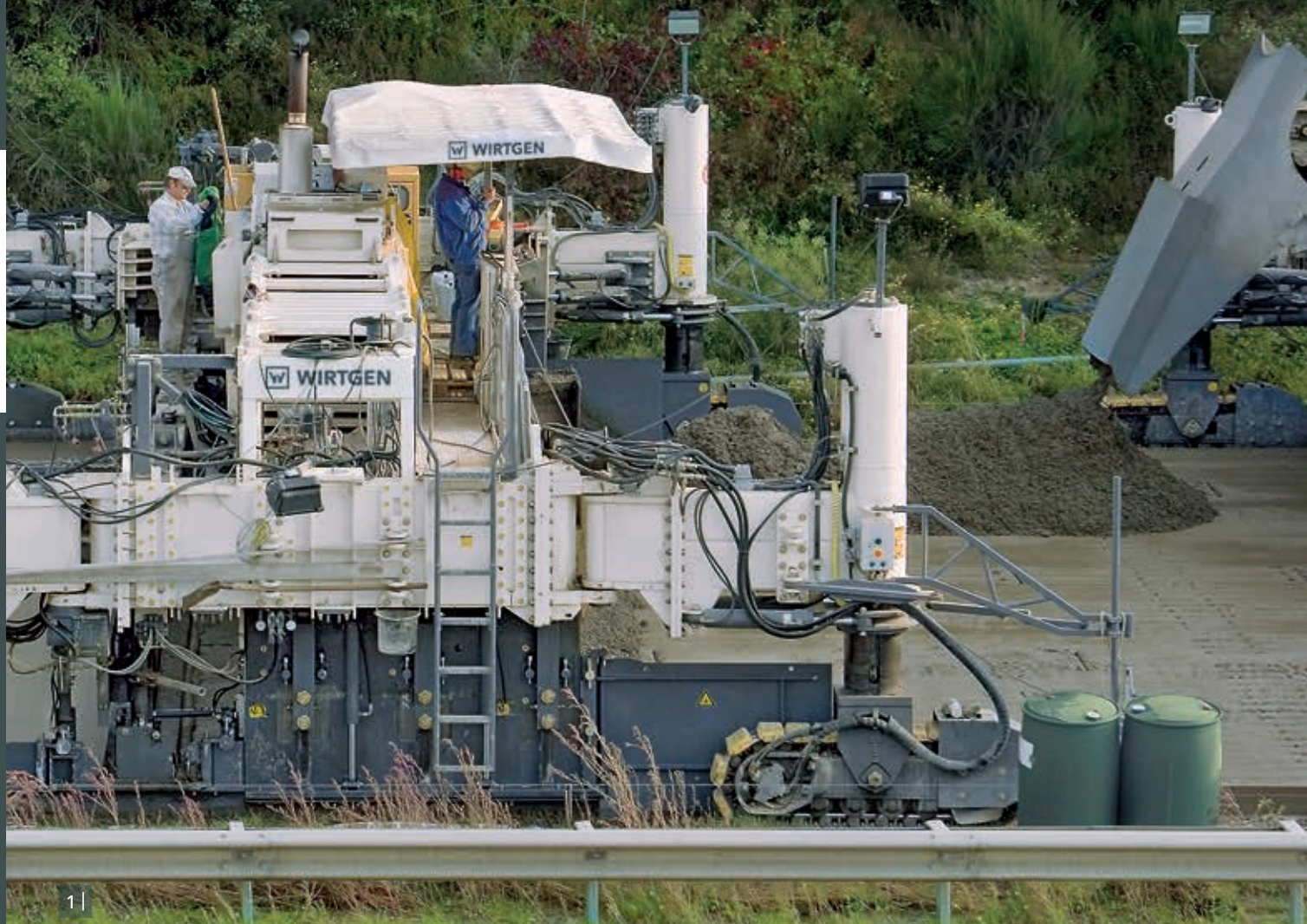

11

The next step: wet-in-wet paving of the top layer

THE SECOND CONCRETE LAYER IS PAVED RIGHT AFTER THE FIRST

Second-to-none, functional solutions geared to field requirements are also used to pave the top-layer concrete. Ingeniously simple: a conveyor transports the top-layer concrete over and across the bottom-layer paver to dump it on the freshly paved bottom concrete layer ahead of the top-layer paver.

The top-layer paver drives over the concrete at a constant speed, spreading it over the entire width by means of a concrete plough. The top layer is compacted and paved wet-in-wet while the paver keeps moving forward.

Vibrators specially designed for the top-layer concrete provide ideal compaction. The oscillating beam and super smoother then ensure a perfect surface finish.

The high degree of automation enables the operating crew to fully concentrate on monitoring the paving process.

2 |



3 |



1 | Concrete is transported in front of the top-layer concrete paver by means of a belt conveyor.

2 | Uniform distribution of the top-layer concrete over the entire paving width.

3 | Precise scanning via stringline or slab tracer ensures production of a perfectly level surface.

Perfection with the finishing touch: automated smoothing

PERFECT FINISH FOR A PERFECT SURFACE

An ideal surface finish is one factor determining the quality and service life of a pavement. The SP 1500/SP 1500 L is a cut above in this category as well because it delivers outstanding results.

The top-layer concrete is paved wet-in-wet and bonds perfectly with the bottom layer. As the machine continues to travel, the oscillating beam and downstream super smoother move over the pavement, with the oscillating

beam oscillating transverse to and the super smoother oscillating in the direction of travel. This combination reliably produces the specified surface texture.

Dual, hydraulically adjustable sideplates guarantee only minor concrete losses. In addition, the trailing and deep paving moulds designed with a view to the paving thickness produce perfect concrete edges.

1 | *After super-smoothing, the concrete slab meets all quality requirements.*



2 | Hydraulically adjustable side-plates ensure clean concrete edges.



3 | The heavy-duty oscillating beam produces an even surface.

4 | Cost-intensive material need only be used for the thin top layer.



1 |

From a single supplier: texture curing for optimum results

ENGINEERED RIGHT DOWN TO THE LAST DETAIL

The paving train is equipped with a multitude of practical, time-saving features. These include the tried-and-tested texture curing machine which follows right behind the two slipform pavers. To achieve optimum skid resistance of the surface, it applies a burlap or cross broom to the freshly paved concrete.

In a final step, a special liquid is sprayed across the entire width of the concrete pavement for effective protection against premature evaporation and cracking. In addition, exposed aggregate concrete surfaces can be produced or longitudinal brooms applied without difficulty.

The operator's platform of the texture curing machine offers excellent visibility. All controls are arranged in line with ergonomic principles. Extended uptimes are guaranteed by a large storage container for the curing compound. The machine's range of applications is extended further by ancillary equipment, such as a separate generator or crane.



2 |



1 | The texture curing machine is used to produce the specified surface texture.

2 | Dispersion is sprayed in a final step to prevent evaporation and cracking.

Technical specification

SP 1500

22
23

	SP 1500
Range of applications	Slab paving
Concrete spreading	
Spreading plough for working width	5,000-15,250 mm
Slab paving equipment for bottom-layer concrete	
Working width	5,000-15,250 mm * ¹
Paving thickness	0-400 mm * ¹
Transverse camber adjustment	0-3 %
Dowel bar inserter	
Working width	5,000-15,250 mm * ²
Diameter of dowel bars	25-40 mm * ²
Dowel bar length	450-600 mm * ²
Longitudinal joint tie bar inserter	
Diameter of tie bars	20-40 mm * ³
Tie bar length	400-1,200 mm * ³
Vibration for bottom-layer concrete	
Connectors for electric vibration	16, can be extended to 48 (option)
Number of electric vibrators, curved	16, can be extended to 48 (option)
High-frequency generator	80 kVA
Slab paving equipment for top-layer concrete	
Working width	5,000-15,250 mm * ¹
Paving thickness	0-500 mm * ¹
Transverse camber adjustment	0-3 %
Oscillating beam	
Working width	5,000-15,250 mm
Super smoother	
Working width	5,000-15,250 mm
Side tie bar inserter	
Diameter of tie bars	20-40 mm * ³
Tie bar length	400-800 mm * ³
Vibration for top-layer concrete	
Connectors for electric vibration	16, can be extended to 32 (option)
Number of electric T-vibrators	10, can be extended to 32 (option)
High-frequency generator	80 kVA

*¹ = Please consult factory for different offset geometries or special applications

*² = Applicable for the range of dowel bar dimensions specified; for any other dimensions, please consult factory; the dowel bar inserters will be customized in accordance with pre-selected customer requirements

*³ = The range of tie bar dimensions specified above can be covered; for any other dimensions, please consult factory; the longitudinal joint tie bar and side tie bar inserters will be customized in accordance with pre-selected customer requirements

	SP 1500
Engine	
Engine manufacturer	Caterpillar
Type	C11 ATAAC
Cooling	Water
Number of cylinders	6
Rated power at 2,100 min ⁻¹	287 kW/385 HP/390 PS
Displacement	11,100 cm ³
Fuel consumption, full load	78.7 l/h
Fuel consumption in field mix	35.4 l/h
Emission standards	EC Stage 3a/US Tier 3
Electrical system	24 V
Filling capacities	
Fuel tank	880 l
Hydraulic fluid tank	420 l
Water tank	870 l
Driving characteristics	
Operating speed	0-6 m/min
Travel speed	0-25 m/min
Track units	
Number	4
Steering angle	±30°
Dimensions (L x W x H)	2,100 x 350 x 715 mm
Height adjustment of machine	
Max. hydraulic height adjustment	950 mm
Transport dimensions (L x W x H)	
Machine for bottom-layer concrete, working width 15,250 mm	21,500 mm x 3,800 mm x 3,100 mm
Machine for top-layer concrete, working width 15,250 mm	21,500 mm x 3,600 mm x 3,100 mm
Machine weights*⁴	
Operating weight, CE* ⁵ of basic machine including options for bottom-layer concrete, working width 15,250 mm	72,080 kg
Operating weight, CE* ⁵ of basic machine including options for top-layer concrete, working width 15,250 mm	60,520 kg
Transport weight of basic machine including options for bottom-layer concrete, working width 15,250 mm	64,560 kg
Transport weight of basic machine including options for top-layer concrete, working width 15,250 mm	57,620 kg

*⁴ = Weights depend on the machine's range of equipment and working width

*⁵ = Weight of machine with half-full water tank, half-full fuel tank, driver (75 kg) and on-board tools

Dimensions

SP 1500

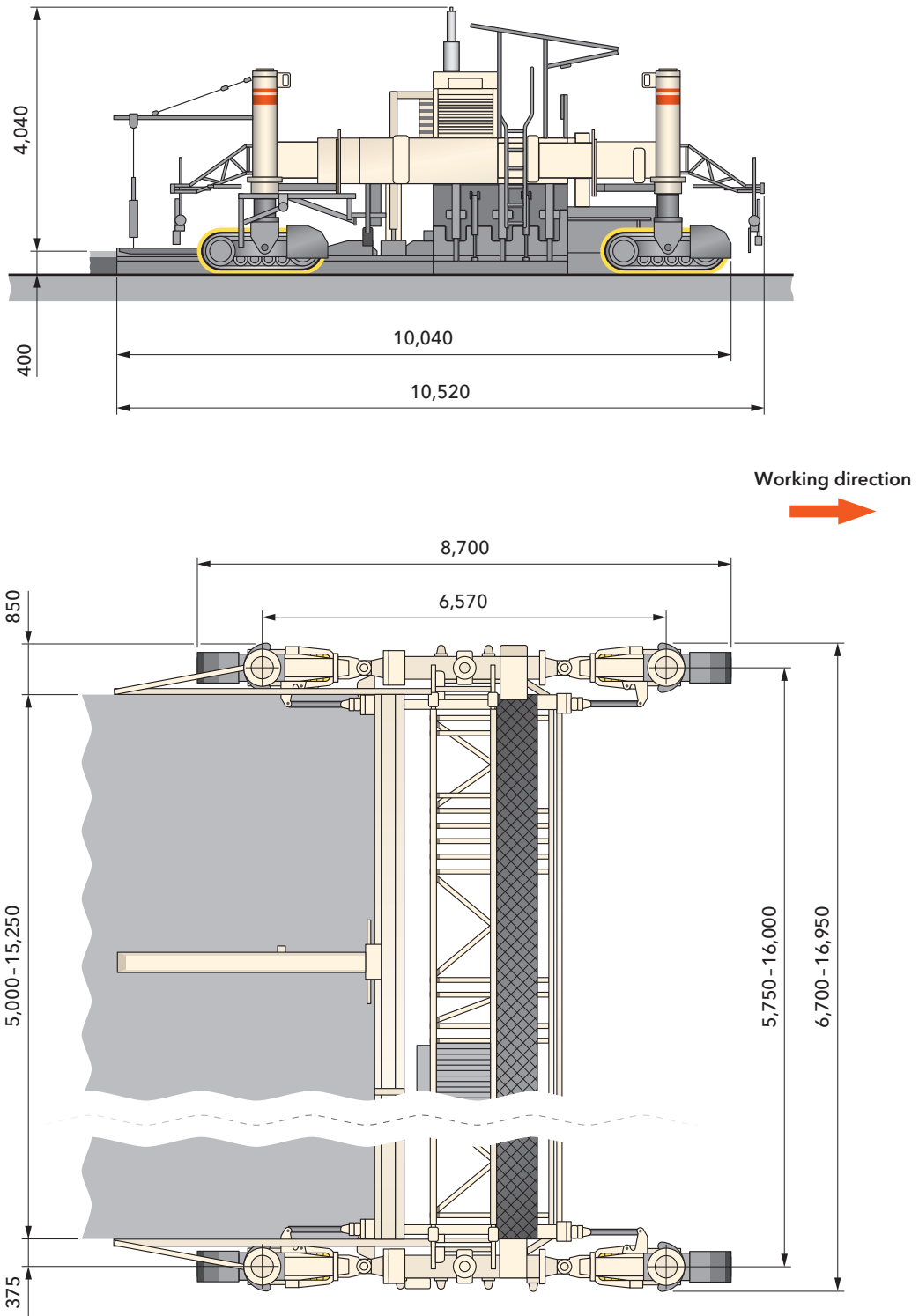

Slipform paver SP 1500, concrete paving equipment for top-layer concrete, 4-track design
Dimensions in mm

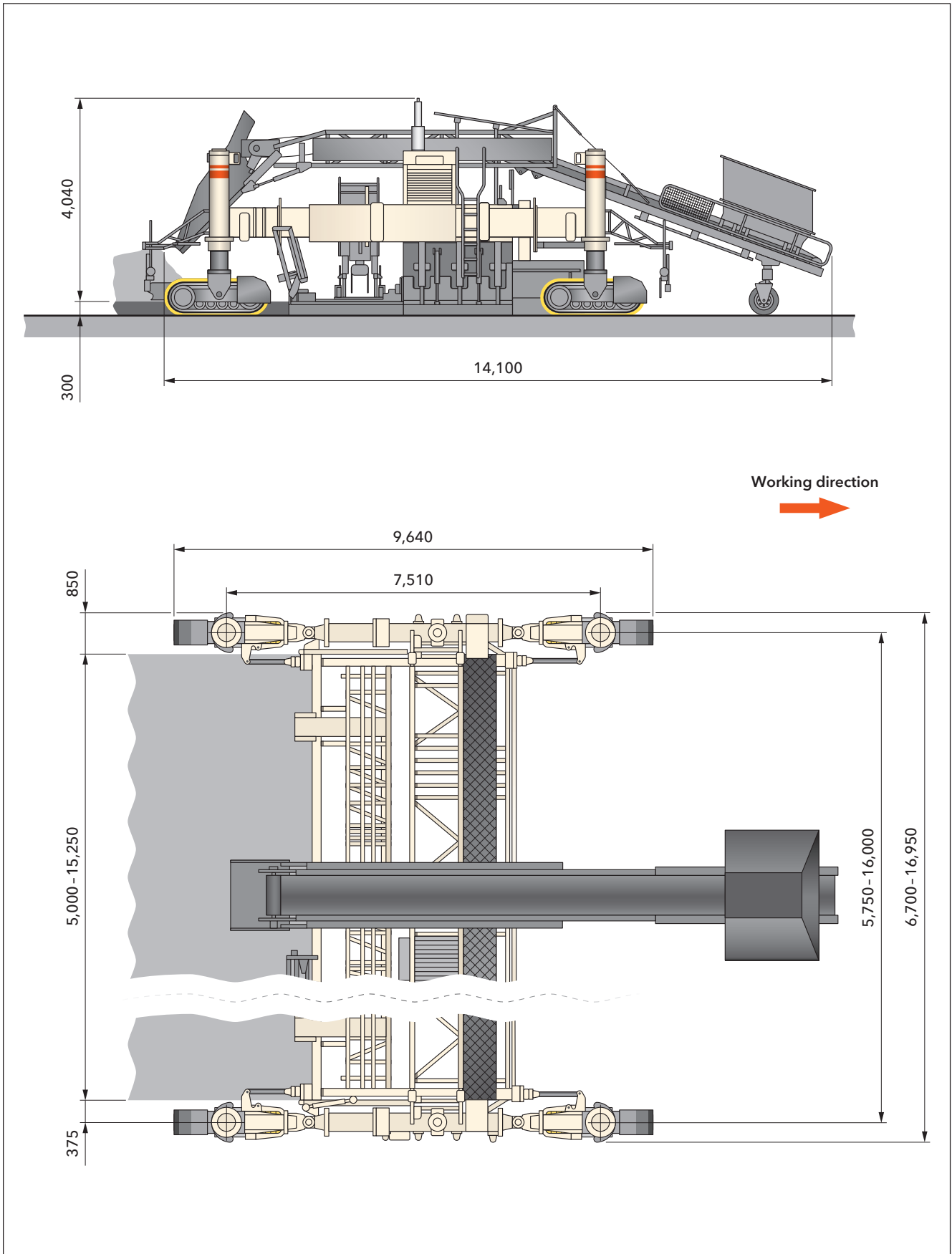

Slipform paver SP 1500, concrete paving equipment for bottom-layer concrete, 4-track design
 Dimensions in mm

Technical specification

SP 1500 L

	SP 1500 L
Range of applications	Slab paving
Concrete spreading	
Spreading plough for working width	5,000 - 15,250 mm
Slab paving equipment for bottom-layer concrete	
Working width	5,000 - 15,250 mm * ¹
Paving thickness	0 - 400 mm * ¹
Transverse camber adjustment	0 - 3%
Dowel bar inserter	
Working width	5,000 - 15,250 mm * ²
Diameter of dowel bars	20 - 40 mm * ²
Dowel bar length	450 - 600 mm * ²
Longitudinal joint tie bar inserter	
Diameter of tie bars	20 - 40 mm * ³
Tie bar length	400 - 1,200 mm * ³
Vibration for bottom-layer concrete	
Connectors for electric vibration	16, can be extended to 48 (option)
Number of electric vibrators, curved	16, can be extended to 48 (option)
High-frequency generator	80 kVA
Slab paving equipment for top-layer concrete	
Working width	5,000 - 15,250 mm * ¹
Paving thickness	0 - 500 mm * ¹
Transverse camber adjustment	0 - 3%
Oscillating beam	
Working width	5,000 - 15,250 mm
Super smoother	
Working width	5,000 - 15,250 mm
Side tie bar inserter	
Diameter of tie bars	20 - 40 mm * ³
Tie bar length	400 - 800 mm * ³
Vibration for top-layer concrete	
Connectors for electric vibration	16, can be extended to 32 (option)
Number of electric T-vibrators	10, can be extended to 32 (option)
High-frequency generator	80 kVA

*¹ = Please consult factory for different offset geometries or special applications

*² = Applicable for the range of dowel bar dimensions specified; for any other dimensions, please consult factory; the dowel bar inserters will be customized in accordance with pre-selected customer requirements

*³ = The range of tie bar dimensions specified above can be covered; for any other dimensions, please consult factory; the longitudinal joint tie bar and side tie bar inserters will be customized in accordance with pre-selected customer requirements

	SP 1500 L
Engine	
Engine manufacturer	Caterpillar
Type	C11 ATAAC
Cooling	Water
Number of cylinders	6
Rated power at 2,100 min ⁻¹	287 kW/385 HP/390 PS
Displacement	11,100 cm ³
Fuel consumption, full load	78.7 l/h
Fuel consumption in field mix	52.5 l/h
Emission standards	EC Stage 3a/US Tier 3
Electrical system	24 V
Filling capacities	
Fuel tank	880 l
Hydraulic fluid tank	420 l
Water tank	870 l
Driving characteristics	
Operating speed	0-7,5 m/min
Travel speed	0-22 m/min
Track units	
Number	2
Steering system	Tank-type steering
Dimensions (L x W x H)	3,350 x 300 x 695 mm
Height adjustment of machine	
Max. hydraulic height adjustment	950 mm
Transport dimensions (L x W x H)	
Machine for bottom-layer concrete, working width 15,250 mm	16,850 mm x 3,800 mm x 3,100 mm
Machine for top-layer concrete, working width 15,250 mm	16,850 mm x 3,600 mm x 3,100 mm
Machine weights^{*4}	
Operating weight, CE ^{*5} of basic machine including options for bottom-layer concrete, working width 15,250 mm	59,580 kg
Operating weight, CE ^{*5} of basic machine including options for top-layer concrete, working width 15,250 mm	48,020 kg
Transport weight of basic machine including options for bottom-layer concrete, working width 15,250 mm	52,060 kg
Transport weight of basic machine including options for top-layer concrete, working width 15,250 mm	45,120 kg

^{*4} = Weights depend on the machine's range of equipment and working width

^{*5} = Weight of machine with half-full water tank, half-full fuel tank, driver (75 kg) and on-board tools

Dimensions

SP 1500 L

28
29

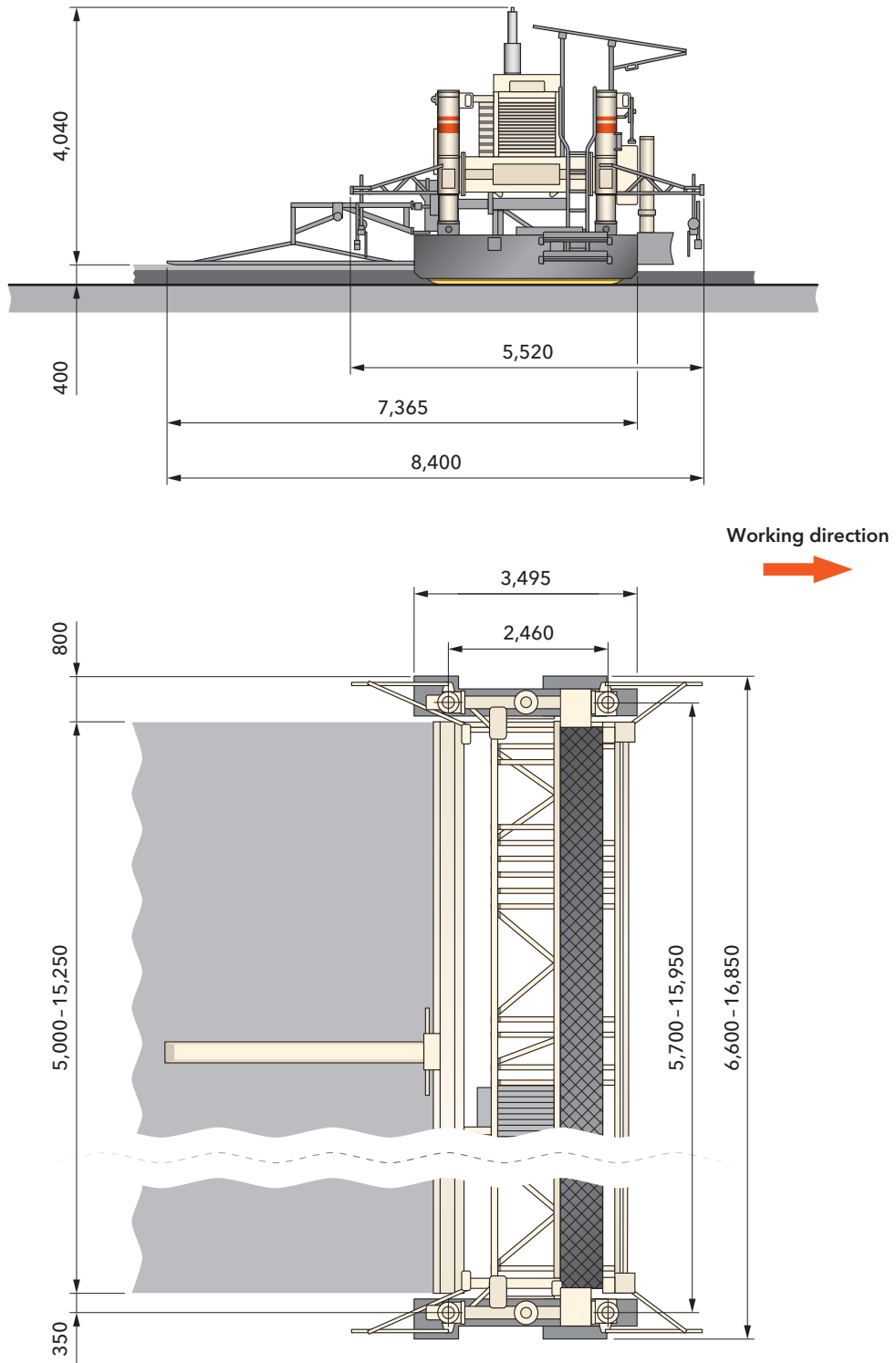

Slipform paver SP 1500 L, concrete paving equipment for top-layer concrete, 2-track design
Dimensions in mm

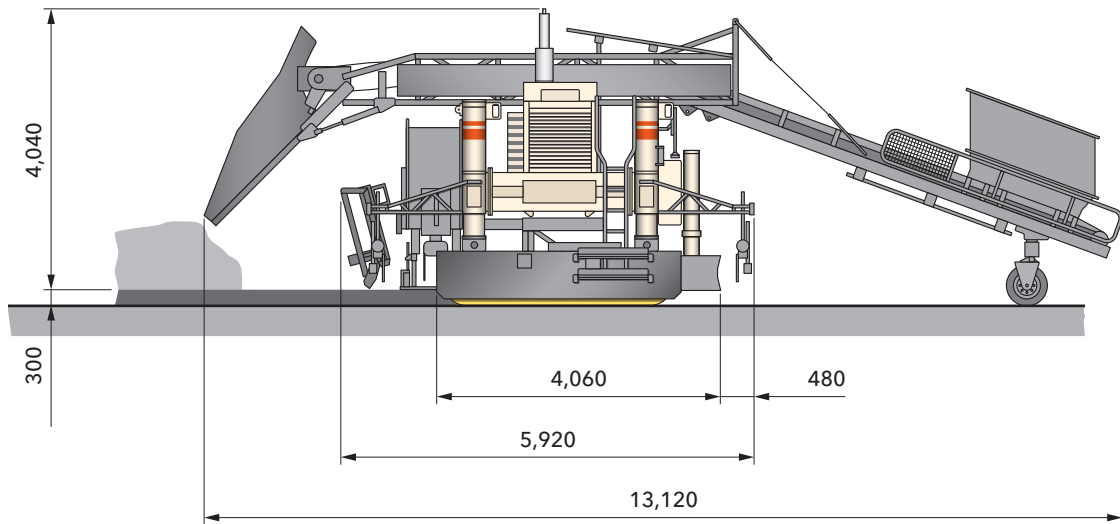

Working direction

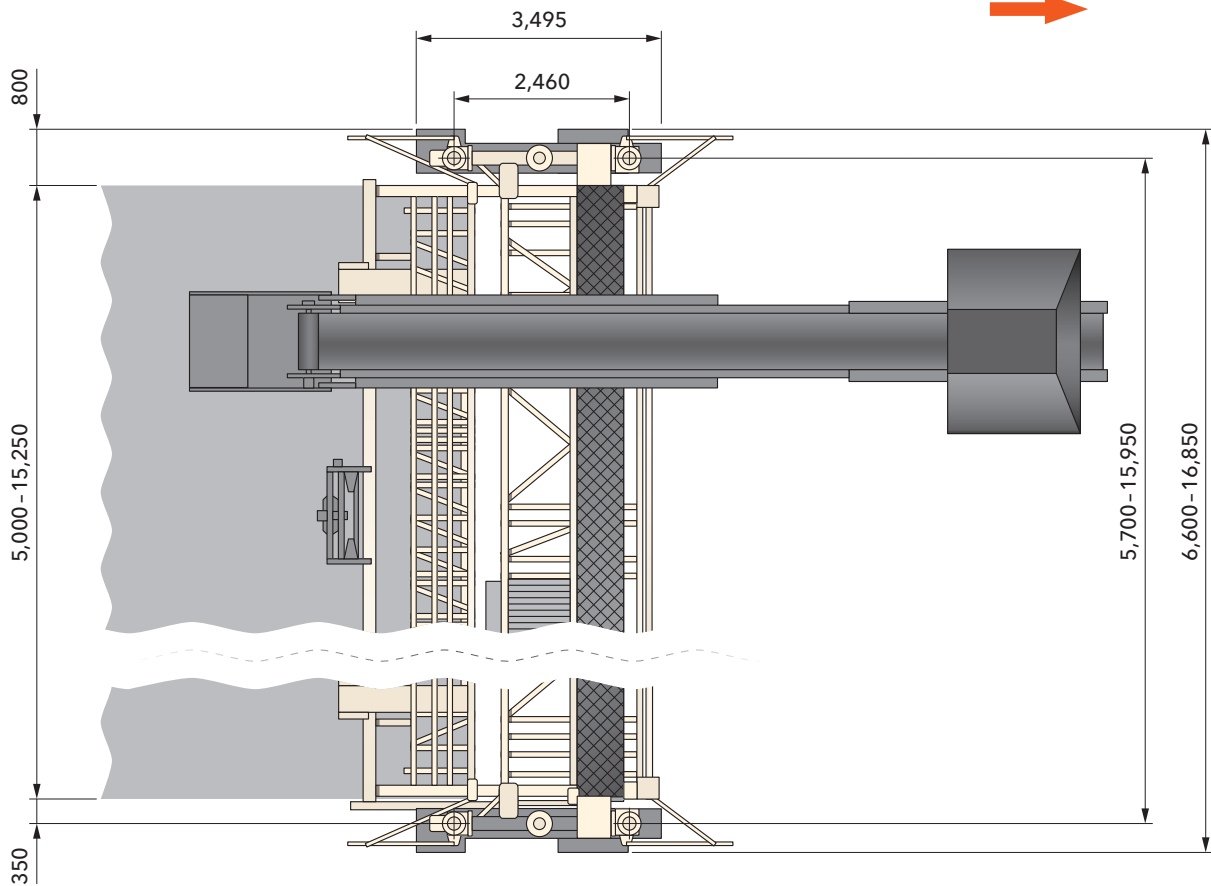

Slipform paver SP 1500 L, concrete paving equipment for bottom-layer concrete, 2-track design
 Dimensions in mm

Standard equipment

SP 1500/SP 1500 L

	Top-layer concrete	Bottom-layer concrete
Base machine		
880 l fuel tank	■	■
420 l hydraulic oil tank	■	■
870 l water tank	■	■
Electrical system (24 V)	■	■
Separate hydraulic oil cooler	■	■
Main transmission with four outputs	■	■
Two hydraulic pumps controlled by servo valve, closed circuit, for the advance drive (2 independent circuits)	■	■
A hydraulic pump controlled by servo valve, closed circuit, for driving the high-frequency generator	■	■
A hydraulic pump controlled by servo valve, closed circuit, for driving the spreader plough	■	■
A pressure-controlled pump, open circuit, for all cylinder functions	■	■
A geared pump for the oil cooler fan	■	■
High frequency generator, 80 kVA, 110 V, 200 Hz, with hydraulic drive motor, for max. 48 vibrators for concrete compacting	■	■
Main frame and height adjustment		
Framework construction in robust, flexurally and torsionally rigid design	■	■
Equipped with paving moulds between the crawler units for a working width of at least 5 m	■	■
The frame with paving mould can be extended to 15.25 m using extension elements	■	■
Crawler unit and crawler unit connections		
Four hydraulically driven crawler units, 2.01 m long with 0.35 m wide PU track pads, transmission ratio 1:305 (SP 1500)	■	■
Two hydraulically driven crawler units, 3.35 m long with 0.30 m wide PU track pads, transmission ratio 1:403 (SP 1500 L)	■	■
Hydraulic motors with two speed ranges	■	■
Four levelling cylinders with 0.95 m stroke	■	■

- = Standard equipment
- = Standard equipment, replaceable with optional equipment
- = Optional equipment

	Top-layer concrete	Bottom-layer concrete
Machine control and levelling and steering		
Digital control system with LCD display which displays all necessary information for the user on a menu and allows parameter settings, e.g. free choice of languages (D/GB/F/E/NL)	■	■
Proportional electrohydraulic levelling and steering by PLC system including four (4) levelling sensors, two (2) steering sensors	■	■
Sensor mountings, adjustable in height and range	■	■
Vibration		
10 horizontal T-vibrators, 500 mm	□	—
16x bended vibrators (D76), electrically driven, with mechanical height adjustment	—	□
Concrete equipment for carriageway paving		
Spreader plough with 2 drives	■	■
Metering gate and guide	■	■
Side header left and right (max. concrete thickness 0.45 m)	■	■
Depth paving mould left and right 0.30 m (others on request)	■	—
Depth paving mould left and right 0.20 m (others on request)	—	■
Oscillating beam 5 m - without crown profile	□	—
Super smoother 5 m - 15.25 m	□	—
Electrical control DBI/TBI	—	□
Automatic dowel bar inserter, base 5 m	—	□
Others		
Lighting package with 5 halogen headlights 24 V	■	■
Paint standard cream white RAL 9001	□	□

- = Standard equipment
- = Standard equipment, replaceable with optional equipment
- = Optional equipment

Optional equipment

SP 1500 / SP 1500 L

32
33

	Top-layer concrete	Bottom-layer concrete
Machine control and levelling and steering		
Slab tracer, 2 pcs	<input type="checkbox"/>	<input type="checkbox"/>
Slab tracer, 4 pcs	<input type="checkbox"/>	<input type="checkbox"/>
Pre-equipment for 3D levelling	<input type="checkbox"/>	<input type="checkbox"/>
Vibration		
Horizontal T-vibrator, electrically driven, 0.50 m wide	<input type="checkbox"/>	—
16x bended vibrators (D76), electrically driven, with hydraulic height adjustment	—	<input type="checkbox"/>
Bent vibrator D76, electrically driven	—	<input type="checkbox"/>
Connection box for 8 vibrators	<input type="checkbox"/>	<input type="checkbox"/>
Hydraulic vibrator height adjustment, from 5 m working width	—	<input type="checkbox"/>
Mechanical vibrator height adjustment from 5 m working width	—	<input type="checkbox"/>
Bulkhead plate, from 5 m working width	<input type="checkbox"/>	<input type="checkbox"/>
Bulkhead plate, can be clamped, from 5 m working width	—	<input type="checkbox"/>
Connection box for max. 8 vibration frames of the dowel bar inserter (DBI)	—	<input type="checkbox"/>
Concrete equipment for carriageway paving		
Automatic metering gate control for concrete paving moulds	<input type="checkbox"/>	<input type="checkbox"/>
Oscillating beam - extension element 0.25 m	<input type="checkbox"/>	—
Oscillating beam - extension element 0.50 m	<input type="checkbox"/>	—
Oscillating beam - extension element 0.75 m	<input type="checkbox"/>	—
Oscillating beam - extension element 1.00 m	<input type="checkbox"/>	—
Oscillating beam - extension element 1.25 m	<input type="checkbox"/>	—
Oscillating beam - extension element 1.75 m	<input type="checkbox"/>	—
Oscillating beam - extension element 2.00 m	<input type="checkbox"/>	—
Dowel bar inserter (DBI) - extension element 0.25 m	—	<input type="checkbox"/>
Dowel bar inserter (DBI) - extension element 0.50 m	—	<input type="checkbox"/>
Dowel bar inserter (DBI) - extension element 0.75 m	—	<input type="checkbox"/>
Dowel bar inserter (DBI) - extension element 1.00 m	—	<input type="checkbox"/>
Dowel bar inserter (DBI) - extension element 1.25 m	—	<input type="checkbox"/>
Dowel bar inserter (DBI) - extension element 1.75 m	—	<input type="checkbox"/>
Dowel bar inserter (DBI) - extension element 2.00 m	—	<input type="checkbox"/>
Base group for dowel bar inserter (DBI) for paving width 5.00 m	—	<input type="checkbox"/>
Base group for dowel bar inserter (DBI) for paving width 6.00 m	—	<input type="checkbox"/>
Base group for dowel bar inserter (DBI) for paving width 7.0 m	—	<input type="checkbox"/>
Base group for dowel bar inserter (DBI) for paving width 8.00 m	—	<input type="checkbox"/>
Base group for dowel bar inserter (DBI) for paving width 9.00 m	—	<input type="checkbox"/>
Base group for dowel bar inserter (DBI) for paving width 10.00 m	—	<input type="checkbox"/>
Base group for dowel bar inserter (DBI) for paving width 11.00 m	—	<input type="checkbox"/>
Base group for dowel bar inserter (DBI) for paving width 12.00 m	—	<input type="checkbox"/>
Base group for dowel bar inserter (DBI) for paving width 13.00 m	—	<input type="checkbox"/>
Base group for dowel bar inserter (DBI) for paving width 14.00 m	—	<input type="checkbox"/>

- = Standard equipment
- = Standard equipment, replaceable with optional equipment
- = Optional equipment

	Top-layer concrete	Bottom-layer concrete
Concrete equipment for carriageway paving		
Base group for dowel bar inserter (DBI) for paving width 15.00 m	-	<input type="checkbox"/>
Base group for dowel bar inserter (DBI) for paving width 16.00 m	-	<input type="checkbox"/>
Longitudinal tie-bar inserter, max. ø 12 - 25 mm, length 800 - 1,200 mm	-	<input type="checkbox"/>
Longitudinal tie-bar inserter, max. ø 12 - 25 mm, length 400 - 800 mm	-	<input type="checkbox"/>
Longitudinal tie-bar magazine for approx. 200 tie-bars with ø 20 mm	-	<input type="checkbox"/>
Paving mould - extension element 0.25 m	<input type="checkbox"/>	<input type="checkbox"/>
Paving mould - extension element 0.50 m	<input type="checkbox"/>	<input type="checkbox"/>
Paving mould - extension element 0.75 m	<input type="checkbox"/>	<input type="checkbox"/>
Paving mould - extension element 1.00 m	<input type="checkbox"/>	<input type="checkbox"/>
Paving mould - extension element 1.25 m	<input type="checkbox"/>	<input type="checkbox"/>
Paving mould - extension element 1.75 m	<input type="checkbox"/>	<input type="checkbox"/>
Paving mould - extension element 2.00 m	<input type="checkbox"/>	<input type="checkbox"/>
Frame extension element 0.25 m (SP 1500 L)	<input type="checkbox"/>	-
Frame extension element 0.50 m (SP 1500 L)	<input type="checkbox"/>	-
Frame extension element 0.75 m (SP 1500 L)	<input type="checkbox"/>	-
Frame extension element 1.00 m (SP 1500 L)	<input type="checkbox"/>	-
Frame extension element 1.25 m (SP 1500 L)	<input type="checkbox"/>	-
Frame extension element 1.50 m (SP 1500 L)	<input type="checkbox"/>	-
Frame extension element 2.00 m (SP 1500 L)	<input type="checkbox"/>	-
Frame extension element 2.50 m (SP 1500 L)	<input type="checkbox"/>	-
Concrete spreading for offset paving		
Belt conveyor for upper layer	-	<input type="checkbox"/>
Operator's stand		
Weather canopy for operator's stand, hydraulically telescoping in height	<input type="checkbox"/>	<input type="checkbox"/>
Others		
Paint in one special colour (RAL)	<input type="checkbox"/>	<input type="checkbox"/>
Paint in two special colours (RAL)	<input type="checkbox"/>	<input type="checkbox"/>
Paint in maximum two special colours with substructure in special colour (RAL)	<input type="checkbox"/>	<input type="checkbox"/>
High pressure cleaner	<input type="checkbox"/>	<input type="checkbox"/>
Additional water tank, black, 1,100 litres	<input type="checkbox"/>	<input type="checkbox"/>
Electric cabinet ventilation	<input type="checkbox"/>	<input type="checkbox"/>
6 halogen headlights 110 V, 500 W	<input type="checkbox"/>	<input type="checkbox"/>
Generator 22 kVA / 400 V / 230 V, including 6 halogen headlights 230 V, 1 kW	<input type="checkbox"/>	<input type="checkbox"/>
Crane system, hydraulic drive	<input type="checkbox"/>	<input type="checkbox"/>
Wire tensioning system, complete with 1,000 m steel wire	<input type="checkbox"/>	<input type="checkbox"/>
Second tensioning winch for levelling the machine using two wire ropes	<input type="checkbox"/>	<input type="checkbox"/>
Daily rate for startup	<input type="checkbox"/>	<input type="checkbox"/>
Export packing	<input type="checkbox"/>	<input type="checkbox"/>

- = Standard equipment
- = Standard equipment, replaceable with optional equipment
- = Optional equipment







WIRTGEN GmbH
Reinhard-Wirtgen-Str. 2 · 53578 Windhagen · Germany
Phone: +49 (0)26 45/131-0 · Fax: +49 (0)26 45/131-392
Internet: www.wirtgen.com · E-Mail: info@wirtgen.com

